

NO.	REVISIONS	DATE	DEVISER
1.			
2.			
3.			

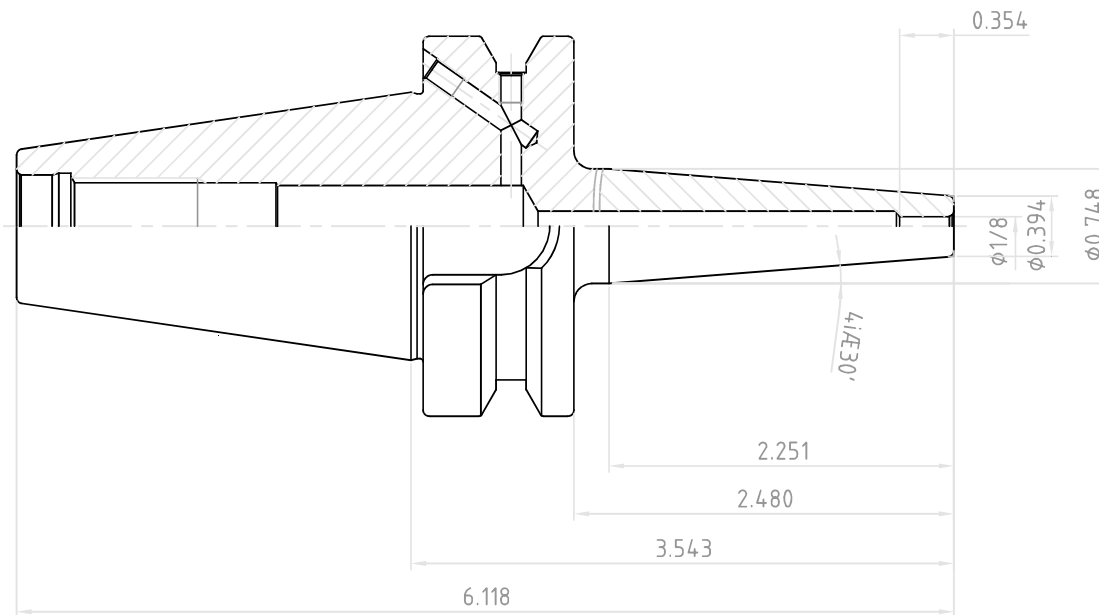

	SSK CONTROL NUMBER	
	BT40AD/B-SFH1/8(3.175)-3.543(90)	
	EDP No.	VH020
		SCALE 1 : 1