

NO.	REVISIONS	DATE	DEVISER
1.			
2.			
3.			

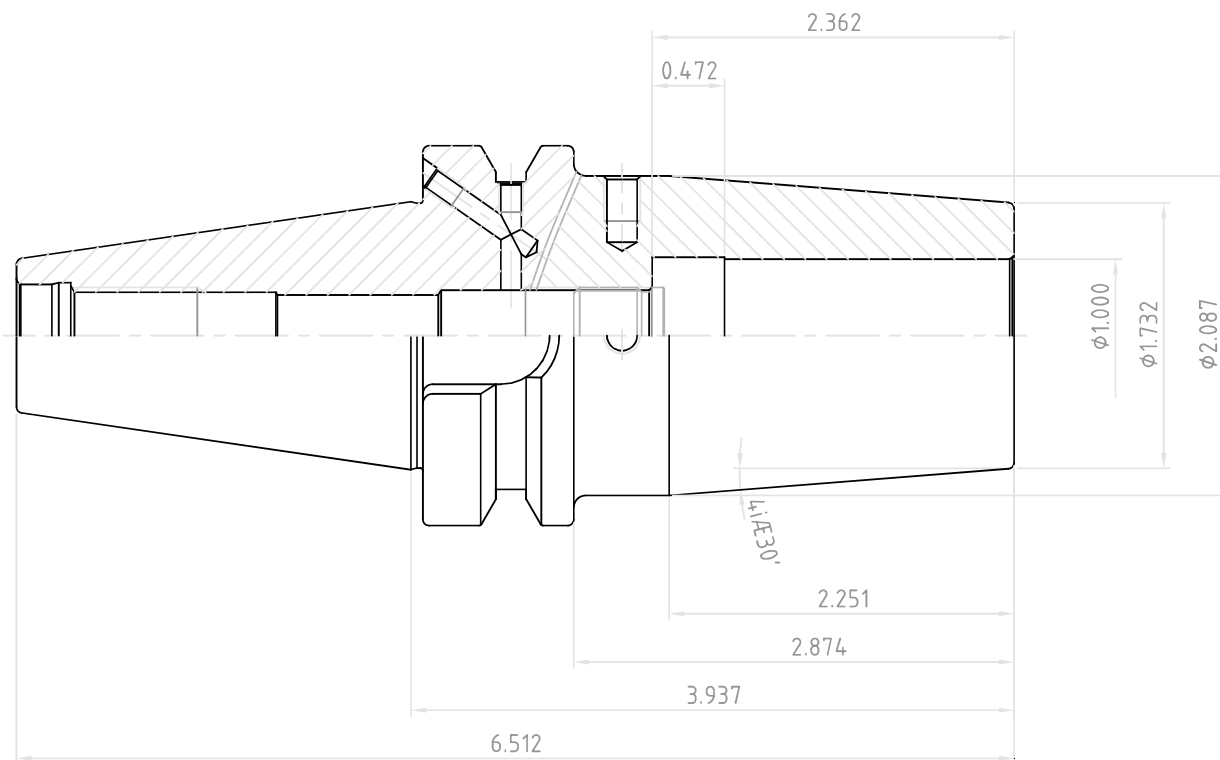

YG-1 CO., LTD.

SSK CONTROL NUMBER

BT40AD/B-SFH1.000(25.4)-3.937(100)

EDP No.

VH044

SCALE

1 : 1