

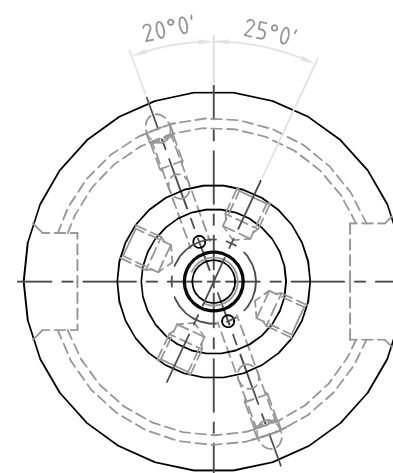

NO.	REVISIONS	DATE	DEVISER
1.			
2.			
3.			

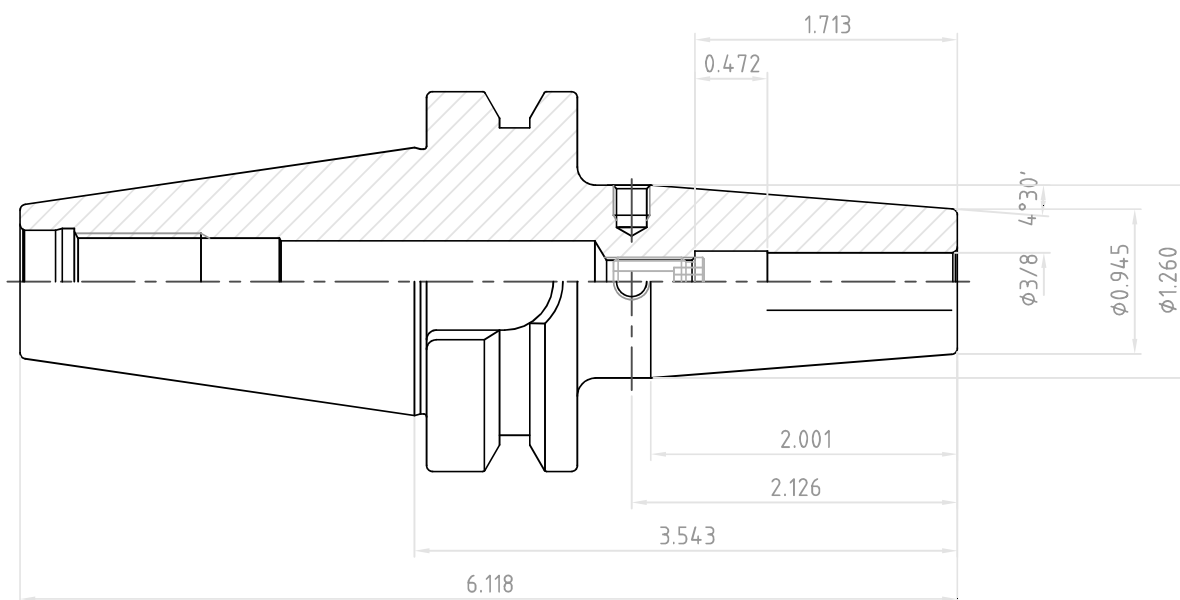
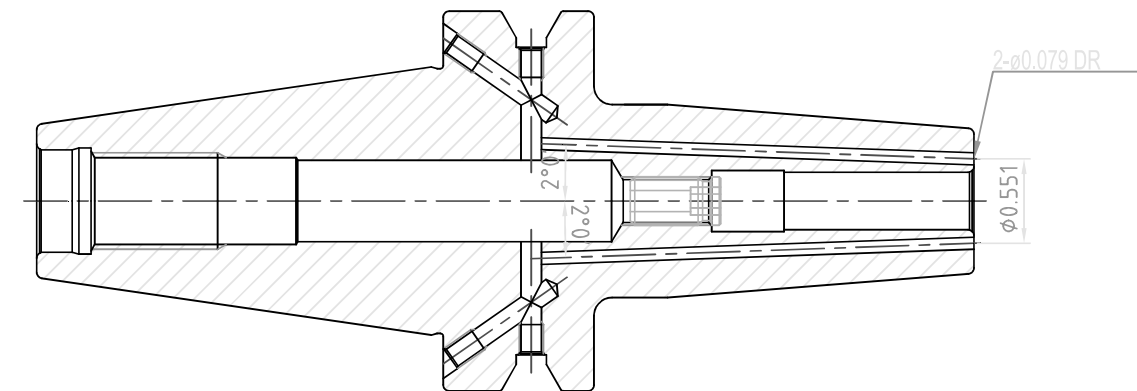

 YG-1 CO., LTD.	SSK CONTROL NUMBER		
	BT40AD/B-SFH3/8(9.525)C-3.543(90)		
EDP No.	VH028J	SCALE	1 : 1