

NO.	REVISIONS	DATE	DEVISER
1.			
2.			
3.			

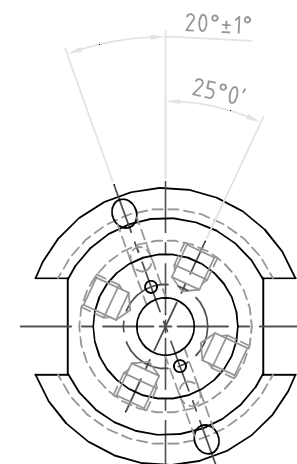
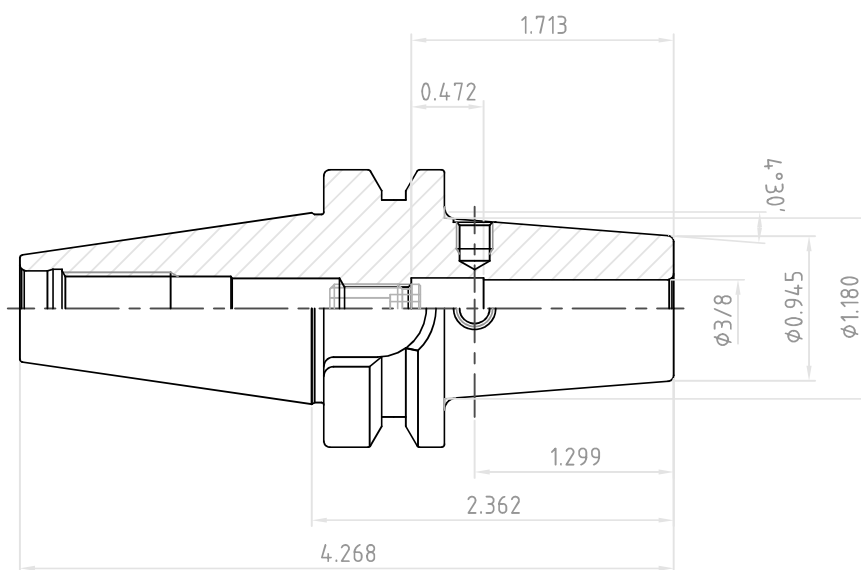
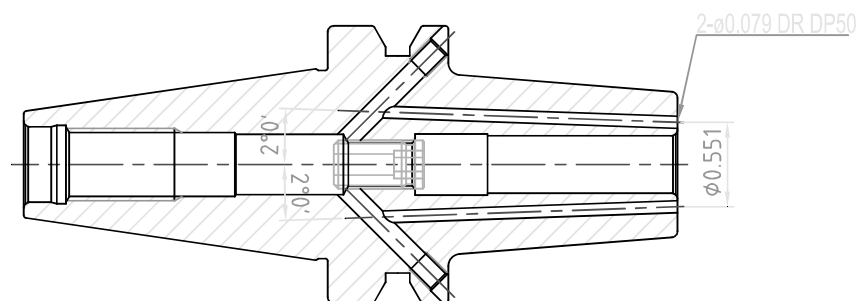

 YG-1 CO., LTD.	SSK CONTROL NUMBER	
	BT30-SFH3/8(9.525)C-2.362(60)	
EDP No.	VG026J	SCALE 1 : 1