

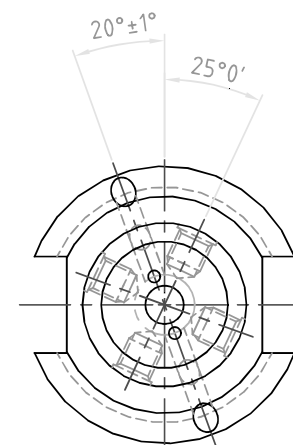

NO.	REVISIONS	DATE	DEVISER
1.			
2.			
3.			

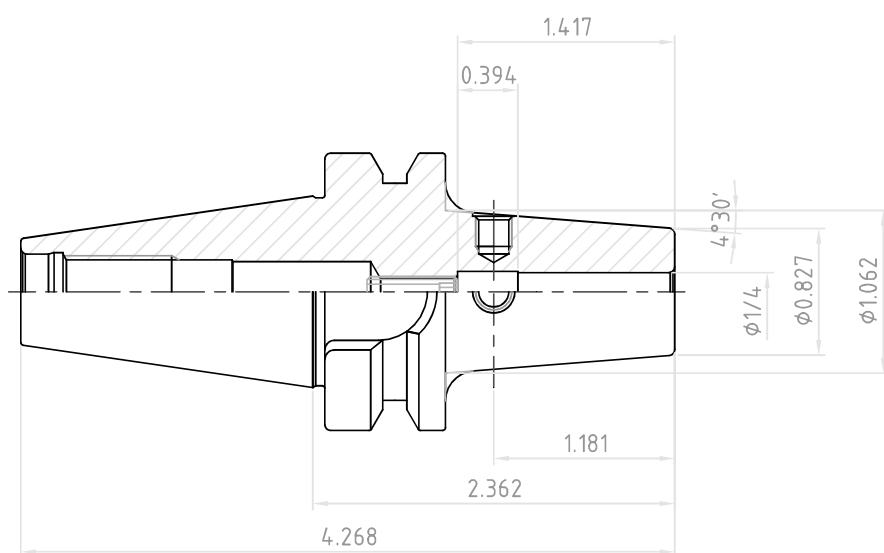
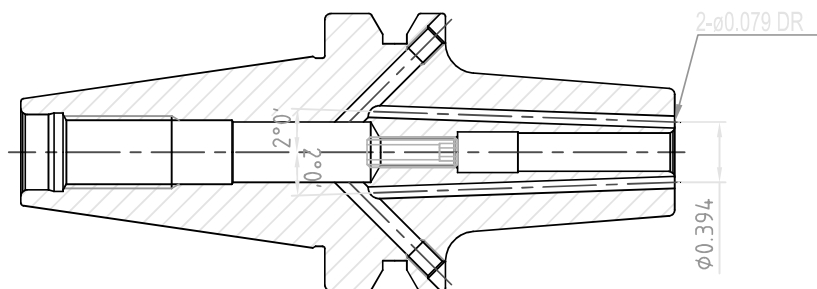

 YG-1 CO., LTD.	SSK CONTROL NUMBER	
	BT30-SFH1/4(6.350)C-2.362(60)	
EDP No.	VG024J	SCALE 1 : 1