

NO.	REVISIONS	DATE	DEVISER
1.			
2.			
3.			

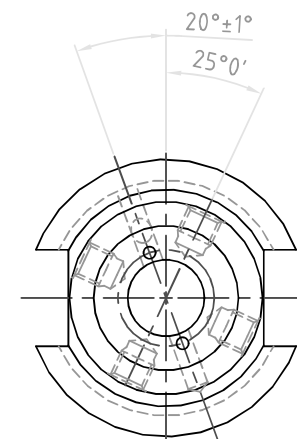
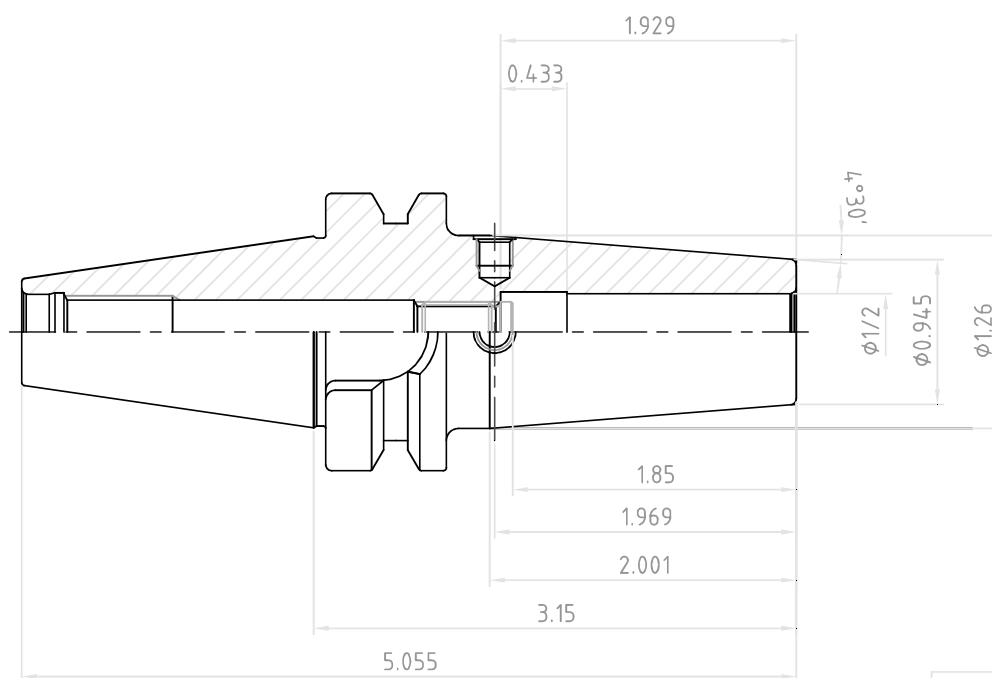
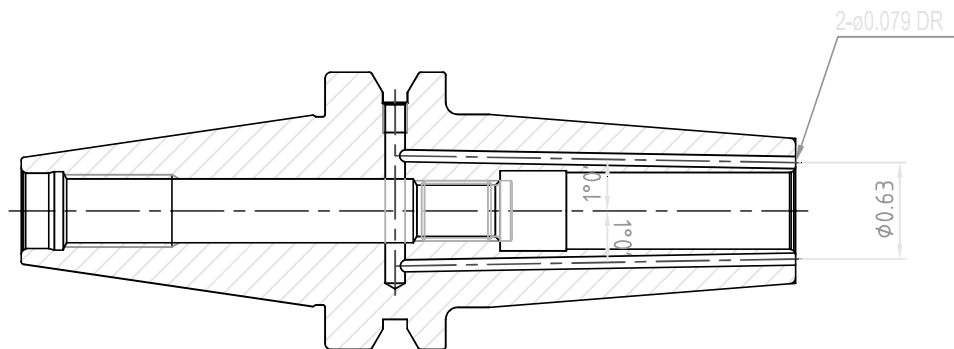

 YG-1 CO., LTD.	SSK CONTROL NUMBER	
	BT30-SFH1/2(12.700)C-3.150(80)	
	EDP No.	VG028J
	SCALE	1 : 1