

NO.	REVISIONS	DATE	DEVISER
1.			
2.			
3.			

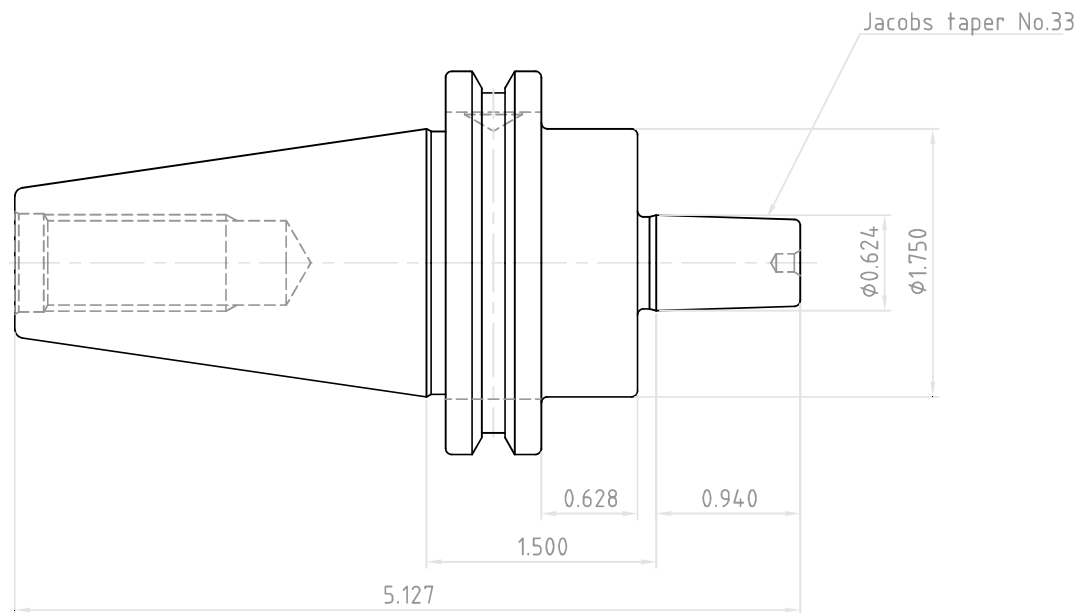

 YG-1 CO., LTD.	DESCRIPTION	
	CAT40-JTA33-1.50(38.1)	
	EDP No.	GK047
	SCALE	1 : 1