

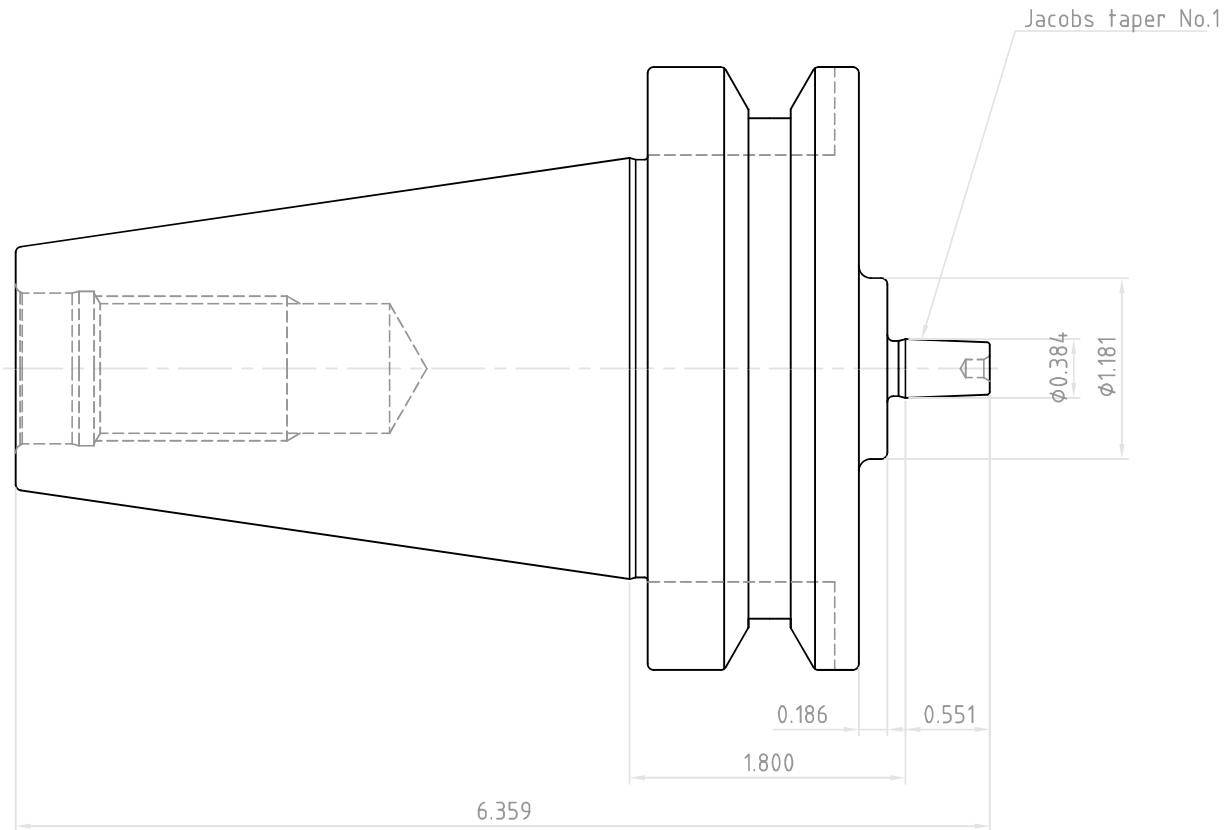

NO.	REVISIONS	DATE	DEVISER
1.			
2.			
3.			



 YG-1 CO., LTD.	DESCRIPTION		
	BT50-JTA1-1.80(45.72)		
	EDP No.	GI042	SCALE 1 : 1