

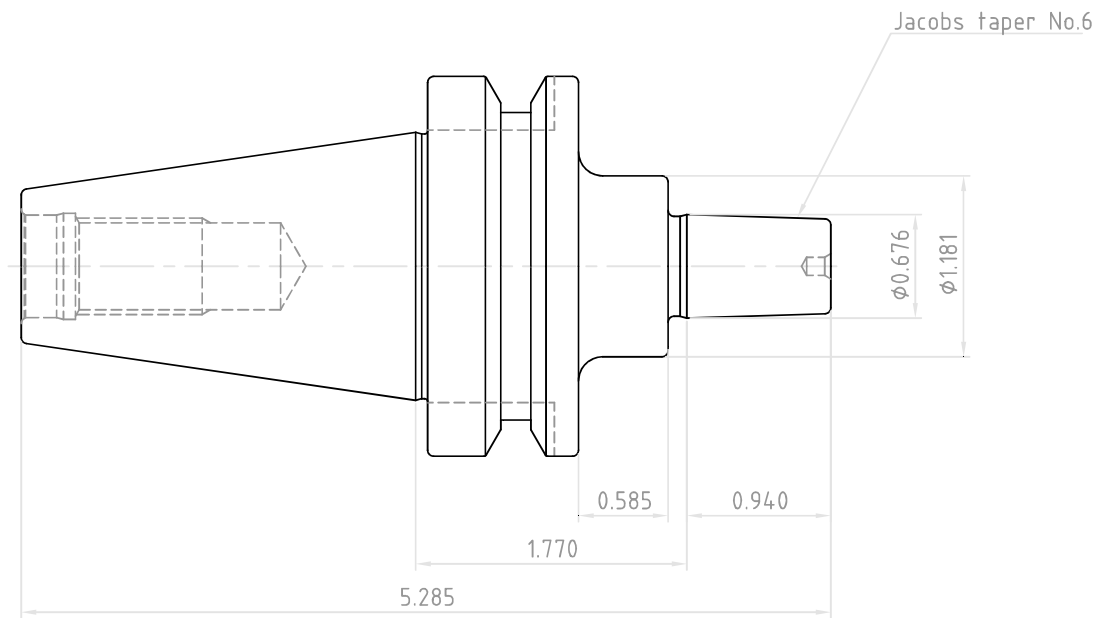

NO.	REVISIONS	DATE	DEVISER
1.			
2.			
3.			



 YG-1 CO., LTD.	DESCRIPTION		
	BT40-JTA6-1.77(44.96)		
	EDP No.	GH046	SCALE 1 : 1